



30TH WORLD RADIOCOMMUNICATION SEMINAR

24 – 28 October 2022

Geneva, Switzerland

IMT general aspects

ITU Radiocommunication Bureau

www.itu.int/go/wrs-22

#ITUWRS

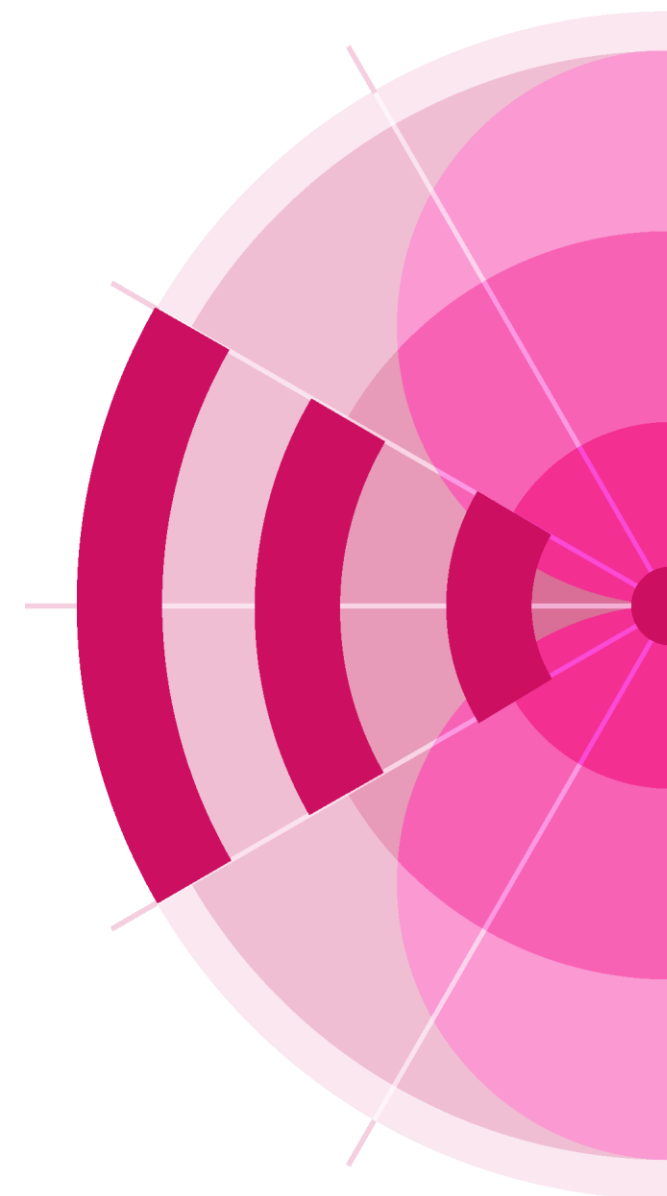

Content of presentation

- Standards and spectrum for IMT
- Balancing spectrum requirements of IMT and other services
- Regional harmonization of IMT bands and technical conditions
- IMT-2020/5G deployment and challenges
- ITU work on IMT for 2030 and beyond/6G

IMT evolution

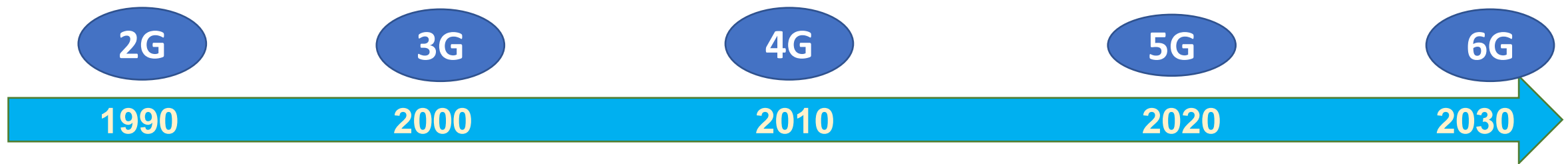

- New generation of cellular communications comes ≈ every 10 years
- 4G (IMT-Advanced) started in 2010. They opened a new era of mobile internet. Serve a basis of many Apps based businesses, e.g. mobile money, hotel, transport reservations, online purchasing, etc.
- 4G became a powerful platform for broadband in developing countries, e.g. for m-Learning, m-Health, Mobile money...
- LTE is the main 4G standard. 4.75 bn subscriptions in January 2022
- 5G (IMT-2020) is now deployed in 87 countries
- Studies on IMT 2030 and beyond (6G) started in ITU, 3GPP, other org.



Current ITU standards of IMT

ITU develops high level IMT standards: Vision, Requirements to characteristics, Criteria of Evaluation of technologies, Detailed Specification

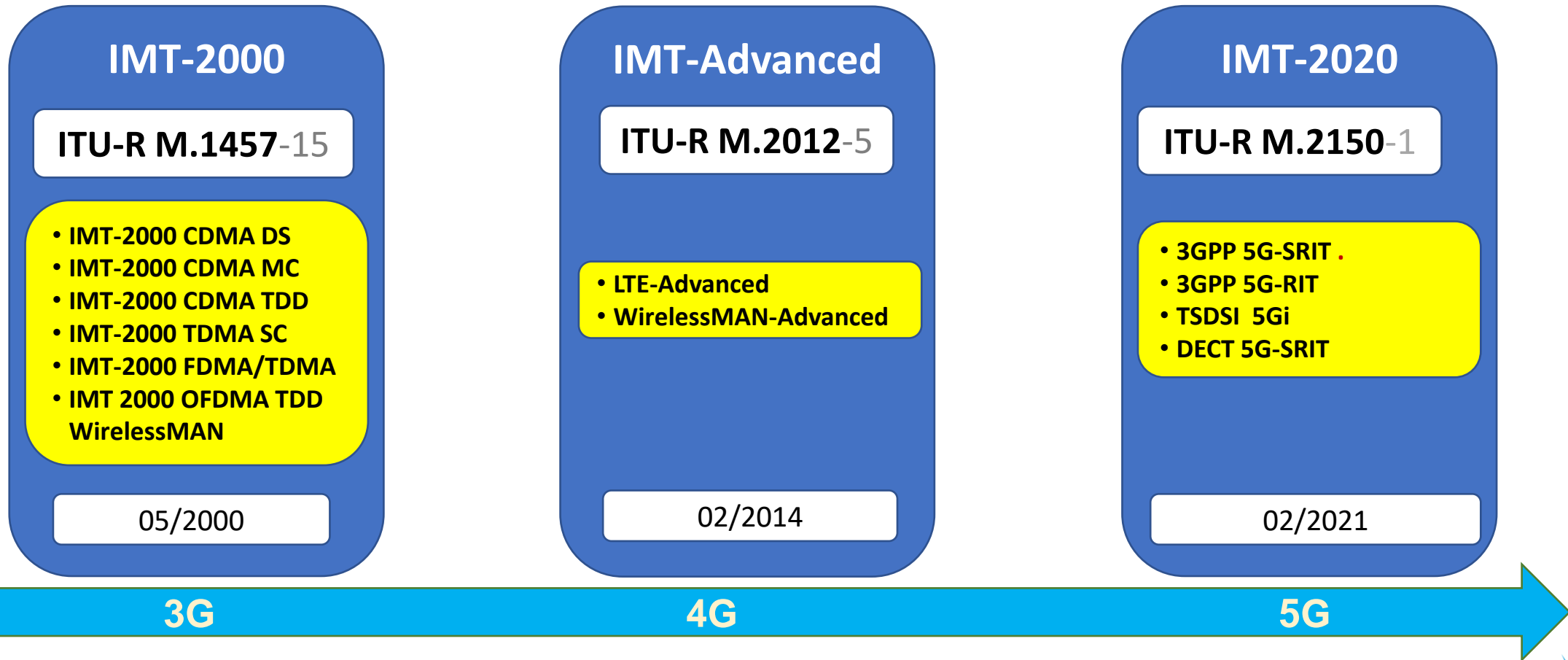

Evolution of IMT generations

4G overtook 3G by subscription number by the end of 2020

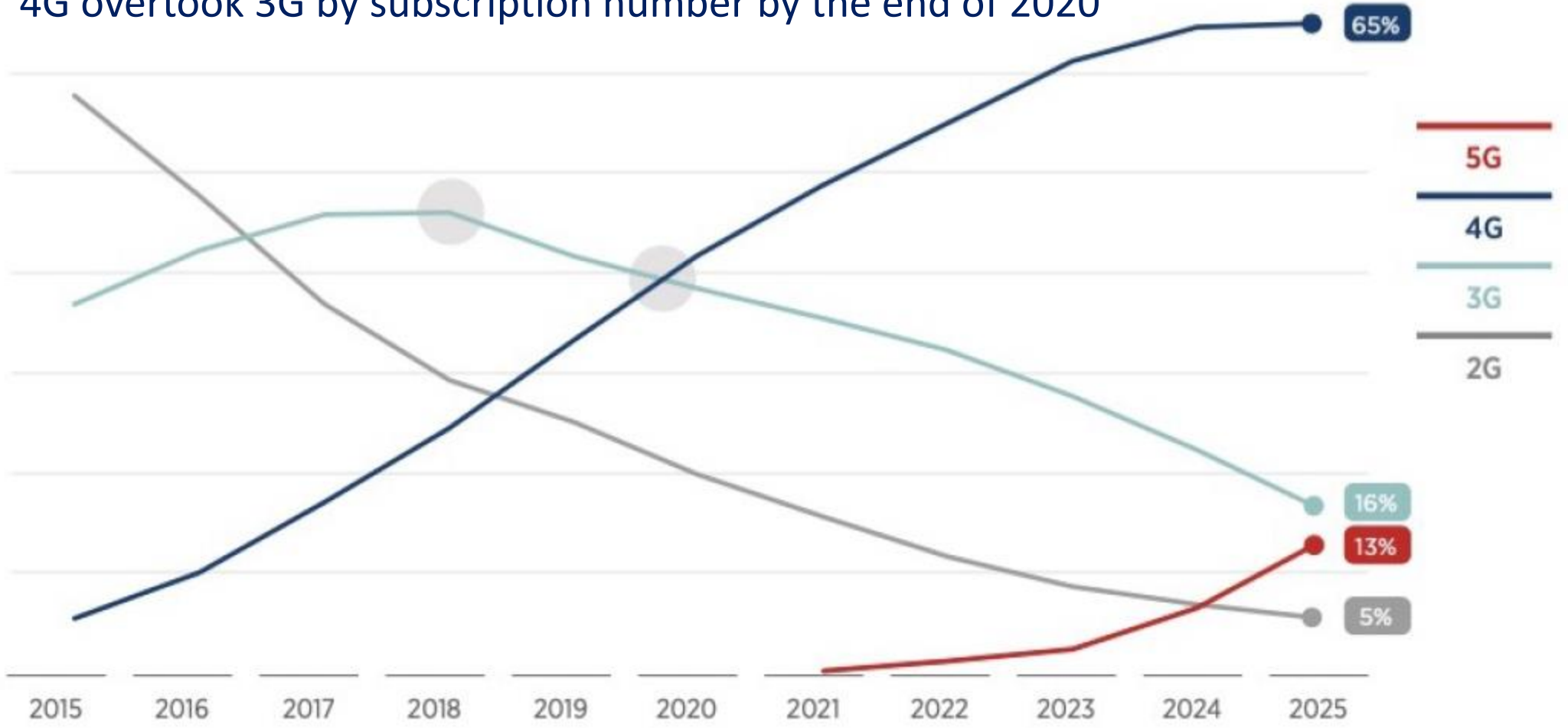

Source: GSMA

Spectrum for IMT

ITU allocates spectrum for IMT at World Radiocommunication Conferences (WRCs)

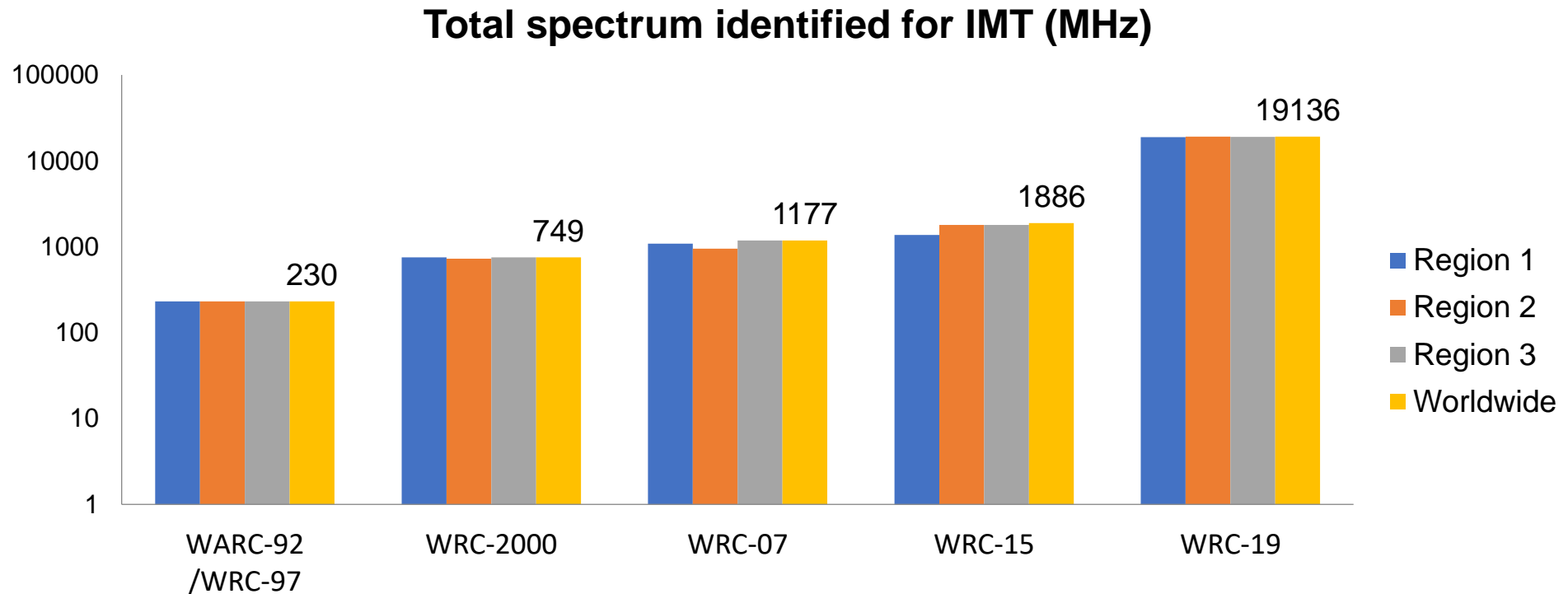

WRC-19 identified **17.25 GHz of spectrum** for IMT in 5 bands. **86%** of these bands are harmonized .

Spectrum for IMT at WRC-23

WRC-23 will consider 7 candidate bands for IMT - UHF band and mid-band frequency ranges

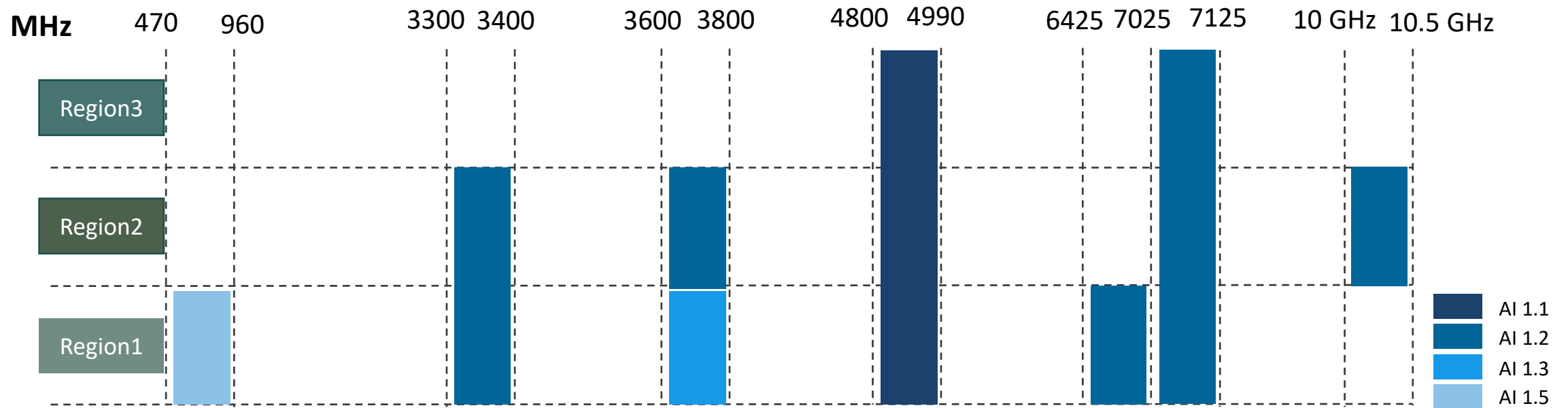

Content of presentation

- Standards and spectrum for IMT
- Balancing spectrum requirements of IMT and other services
- Regional harmonization of IMT bands and technical conditions
- IMT-2020/5G deployment and challenges
- ITU work on IMT for 2030 and beyond/6G



Role of IMT in ICT ecosystem

- **IMT is very important** - ubiquitous connection of people and machines, **but**
- There are other important radio services using spectrum:
 - Fixed networks: RRL, TV distribution, HAPS, mobile networks backhaul
 - Scientific satellites: information about minerals, climate change, weather prediction
 - Radio navigation satellites: location and navigation
 - Communications satellites: comms in remote areas, disaster communications,
 - Radar: navigation, traffic safety, collision avoidance in intelligent transport systems
 - Other mobile services: maritime, air, Wi-Fi
- **Radio spectrum is essential for the operation and development of these services**

Mechanisms for balancing spectrum requirements

- Balanced position of national regulators - care about all radio services
- Mobile community contribution:
 - Realistic mobile traffic forecasts *that are converted into* .
 - Justified spectrum needs
 - Wise choice of candidate frequency bands for IMT .
- WRC mechanism, which guarantees that the interests of the services are taken into account:
 - Principle: allocating frequencies to new services while protecting existing ones
 - ITU studies of all interference scenarios based on realistic assumptions



Compatibility of IMT in adjacent bands

- Success of mobile broadband and its ubiquitous coverage sometimes leads to compatibility issues with other services not only in the same band, but also in adjacent frequency bands. Examples:
 - Potential impact on aircraft altimeters in 4.2 – 4.4 GHz from IMT in bands below 4.2 GHz
 - Potential interference from IMT above 24.25 GHz to passive sensors of space services operating below 24 GHz
 - Impact on the receiving terminals of mobile-satellite service on ships and aircraft in 1518-1525 MHz from IMT operating in a lower band
 - Uncertainties with operation of radio microphones at 700 MHz and possible move out of the band

Issues with radioaltimeters

- Radioaltimeters are critical during all phases of flight, especially landing. RA are sensitive to spurious interference— low filtering in old models
- WRC-12 identified 3.4 - 3.6 MHz for IMT, but countries introduce 5G close to 4.2 - 4.4 GHz
- Both sides, Aviation and 5G develop measures to prevent interference
- These includes developing new filters for RA and restrictions for IMT near airports on power, azimuth, runway distances. Already implemented in F, CAN, USA, CZE, J, ARS

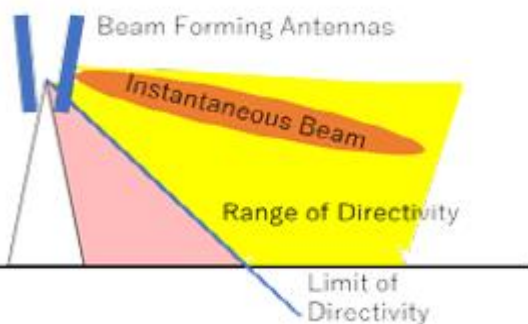
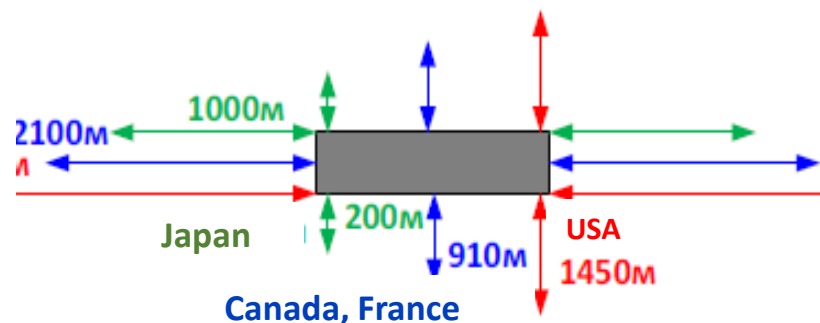
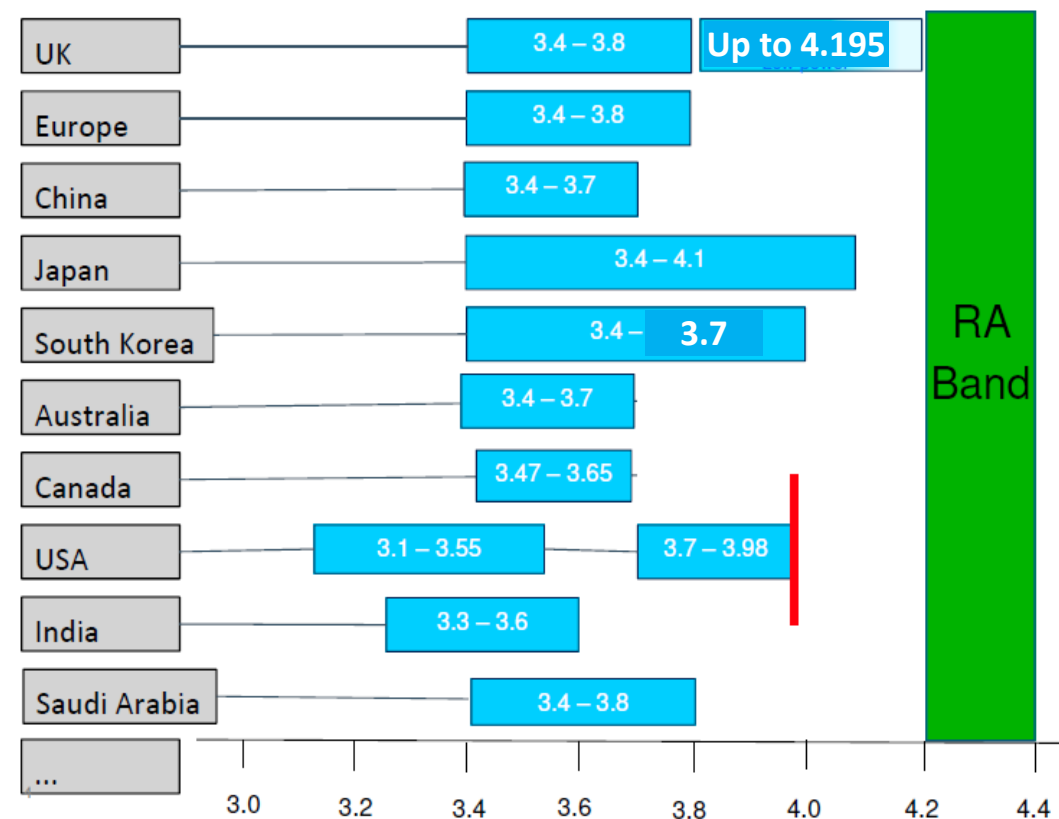

Protection of passive sensors in adjacent band

- **Past** : WRC allocations without analysing adjacent bands interference, except radioastronomy
- **Present**: studies of new allocations include adjacent band compatibility, WRC-23:
 - Mid-band frequencies for IMT (3300-3400, 3600-3800, 6425-7125, 10.0-10.5 GHz)
 - New frequencies for HAPS below 2.7 GHz
- **Good example**: WRC-19 ensured protection of space sensors from 5G in 24 GHz
 - established unwanted emission limits on 5G stations to protect sensors below 24 GHz
 - Limits are in Res 750 (Rev.WRC-19), 2 phase implementation, more stringent after 2027

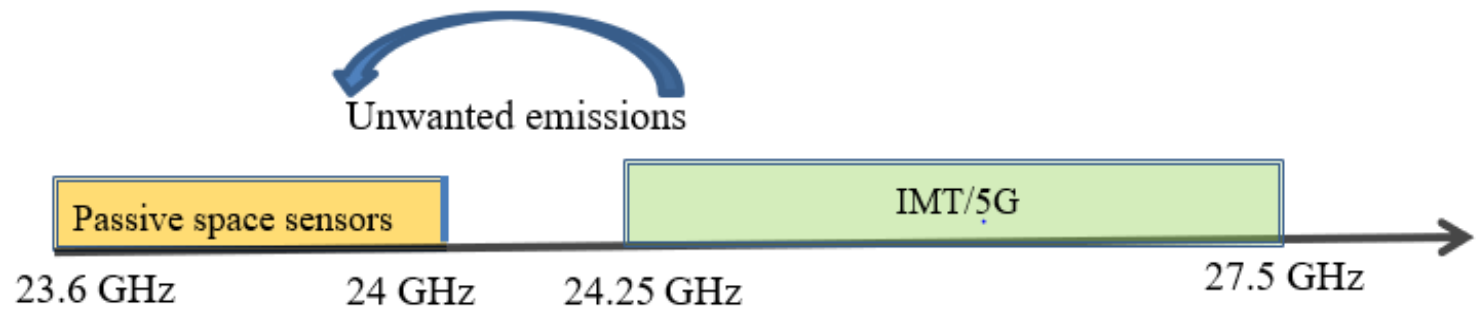

Content of presentation

- Standards and spectrum for IMT
- Balancing spectrum requirements of IMT and other services
- Regional harmonization of IMT bands and technical conditions
- IMT-2020/5G deployment and challenges
- ITU work on IMT for 2030 and beyond/6G

Regional IMT harmonization - approaches

4 levels of harmonization:

- Developing harmonized frequency channelling plans for IMT
 - Basis : ITU-R Rec. ITU-R M.1036 + best practices of regions
- Defining harmonized technical conditions of IMT operation for each frequency band
- Developing and approving guidance on IMT cross-border coordination:
 - coordination methodology
 - technical criteria
 - mitigation techniques
- Concluding bilateral or multilateral coordination agreements

Level 1: Harmonized frequency plans – African example

RF Arrangements (MHz)	Mobile Station Transmitter	Base Station Transmitter	Priority
D12	450.0–455.0	460.0–465.0	Medium
D13	451.0–456.0	461.0–466.0	
D14	452.5–457.5	462.5–467.5	
A2	880–915	925–960	High
A3	832–862	791–821	High
A11 (harmonized with A7 and A10)	703–733 External	758–788 738–758	High
G3	1 427-1 517 (TDD)		Medium
B1	1 920–1 980	2 110–2 170	High
B2	1 710–1 785	1 805–1 880	High
E1	2 300-2 400 (TDD)		
C1	2 500–2 570	2 620–2 690	High
C3	2 500–2 690 MHz		High
	3300–3400 (TDD)		High
F1	3 400–3 600 (TDD)		High
H1	4 800–4 990 (TDD)		Medium

Technical conditions

- Harmonized technical conditions may include (*below is example of the conditions for the band 3 400 – 3 800 MHz in CEPT*)
 - Duplex mode of operation, FDD or TDD (*TDD*)
 - Block sizes (*in multiples of 5 MHz*)
 - Recommended contiguous spectrum for operators (*preferably 80–100 MHz*)
 - Power limits, maximum e.i.r.p. spectral density (*+53 (dBm/MHz) for base, +25 mobile*),
 - Block Edge Masks - both in-block and outside block (*graphs or formulas*)

3400-3800 MHz frequency arrangement - Europe

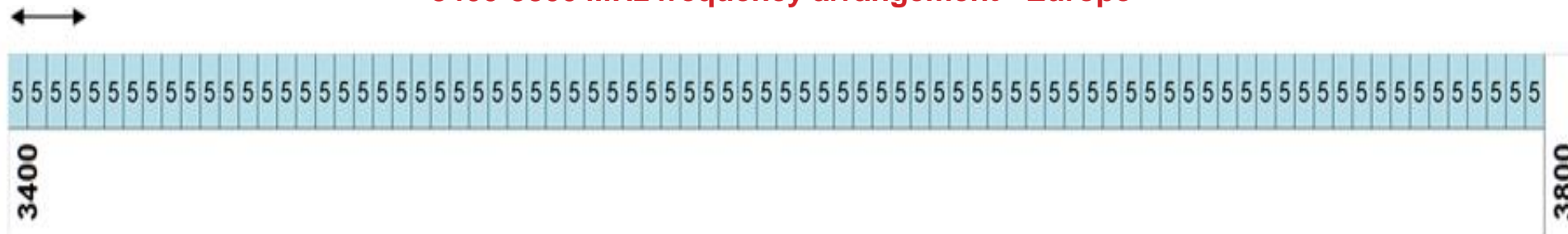

Cross border coordination approaches

- Establishing field strength limits. E.g. 700 MHz for LTE and 5G, see CEPT Rec. (15)01
 - 59 dB μ V/m/(5 MHz) at 3 m at the borderline between countries and
 - 41 dB μ V/m/(5 MHz) at 3 m at 6 km inside the neighbouring country (in 700 MHz)

If emissions below the limits – no coordination. If the limits are exceeded - coordination

- Usage of preferential:
 - Frequencies for 2G – GSM
 - Codes for 3G CDMA - UMTS
 - PCIs (Physical-layer Cell Identity) for 4G and 5G (LTE and 5G-NR)
- Developing coordination guidance. It may include methods of coordination, criteria of coordination, propagation models, data for exchange of information between countries...

Coordination of TDD systems

- TDD networks are more spectrum efficient than FDD, but less simple to coordinate
- Effective coordination technique for TDD systems: their **Synchronization**
- Through identification of **common frame structures** on both side of the border to avoid simultaneous UL/DL transmissions

Recommended frame structures for TDD MFCN cross-border coordination in 3400-3800 MHz

- Limitations: existing networks may have constrains on frame structures
- So, it could be used for future 5G systems

	Frame A			Frame B		
DL/UL slot pattern	DDDSU DDSU DDSU DDSU (see note 1)			DDDSUDDDD DDSUDDDD (see notes 1, 4)		
Frame duration	10 ms			10 ms		
Slot Duration	0.5 ms			0.5 ms		
Slot pattern periodicity	2.5 ms			5 ms		
Special slot "S" configuration (i.e., DL:GP:UL symbols)	Downlink	Guard period	Uplink	Downlink	Guard period (note 5)	Uplink
	10	2	2	6 4	4 6	4 4
Time base (see note 3)	Start of UTC second epoch (see note 2) +/- 1.5 μ s			Start of UTC second epoch (see note 2) +/- 1.5 μ s		

Example of CEPT Recommendation 20/03: common frame structure for systems in 3400 – 3800 MHz)

Content of presentation

- Standards and spectrum for IMT
- Balancing spectrum requirements of IMT and other services
- Regional harmonization of IMT bands and technical conditions
- **IMT-2020/5G deployment and challenges**
- ITU work on IMT for 2030 and beyond/6G

Status of 5G deployment

July 2022

- 5G deployed in network, services launched
- 5G deployed in network, soft launch
- Deploying/deployed, precommercial
- Planning/evaluating/testing/trialling

218 commercial networks

87 countries

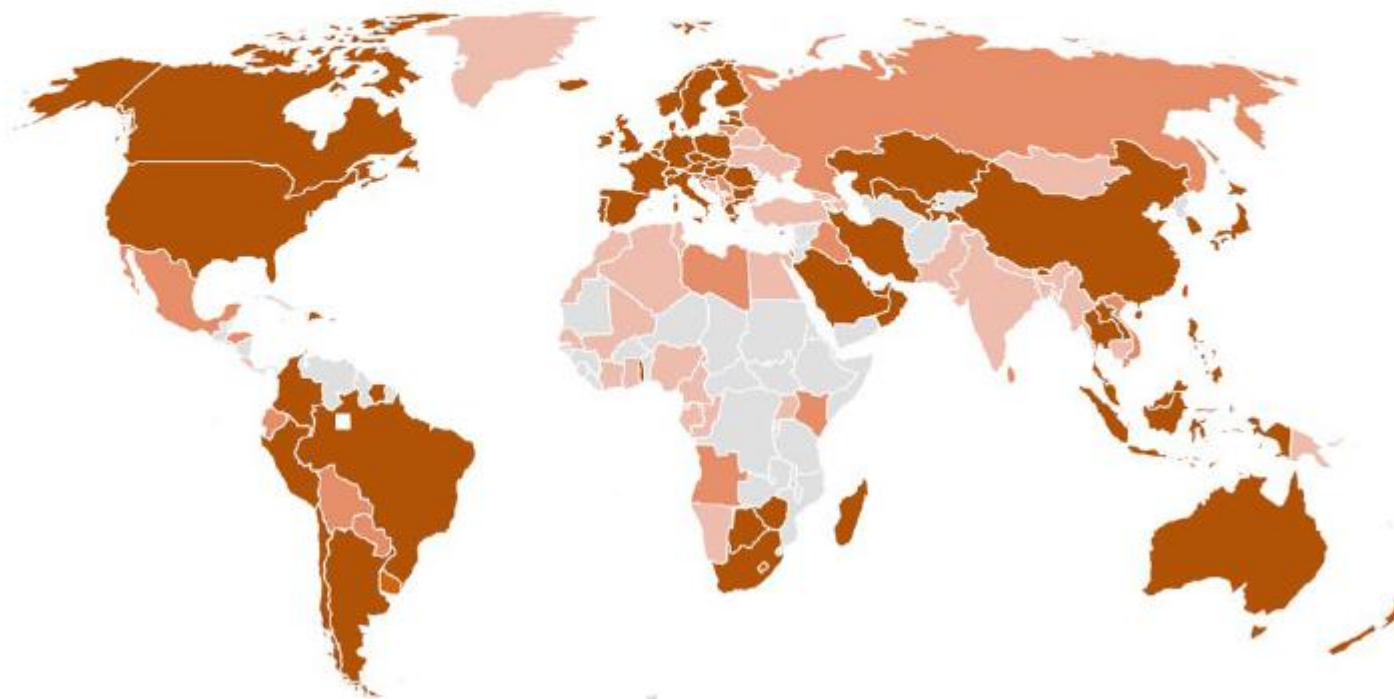

Source: GSA

5G commercialization

5G is searching for sustainable, profitable business models. All use cases, services are explored

Enhanced mobile broadband

- **eMBB is leading 5G usage**
- Broadband in dense areas and everywhere
- 4K/8K and 3D video
- Augmented/ virtual reality
- Last mile wireless access

Massive machine-type communications

- 1mln devices per km²
- Smart cities, ports
- Power, water grids
- Other sensor networks
- Medical and sport wearable

Ultra- reliable and low-latency communications

- Smart factories (robotics, automation)
- High mobility apps (e.g. in trains up to 500 km/h)
- Connected drones
- Autonomous cars

Enhanced broadband – connection of real and virtual worlds

- Apart of higher data rates, 5G offers AR/VR applications - drivers for user migration to 5G
- AR/VR (AR training, shopping, tourism, library..) are in trend with high investments
- 1st 5G Metaverse- **ifland** in KOR in July 2021. More than 1.1 M users by the end of 2021

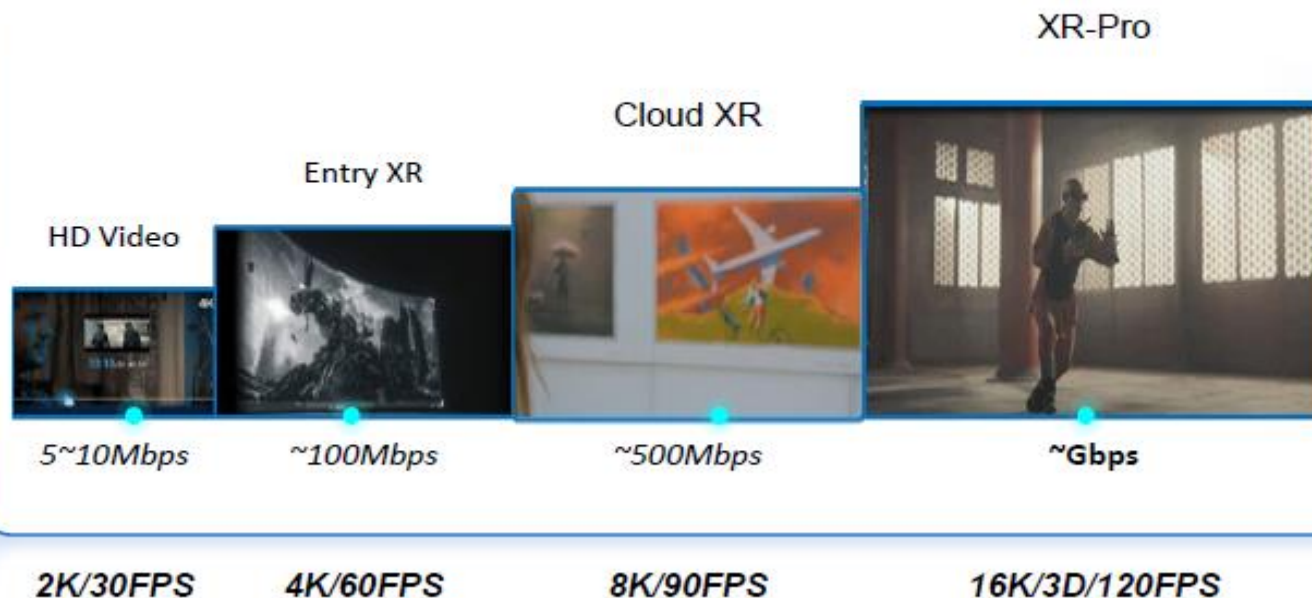

Metaverse – physical and digital integration



64K 6D 120FPS~

Enhanced broadband services – fixed wireless access (FWA)

- FWA – economically attractive option to replace fiber. Mature service of 5G
- FWA could have many applications: internet for villages, rural areas, smart schools and retail, private lines (live broadcast in camps, bus entertainment...)
- More than 90 networks offering 5G FWA services deployed in 2022 (44 in 2020)

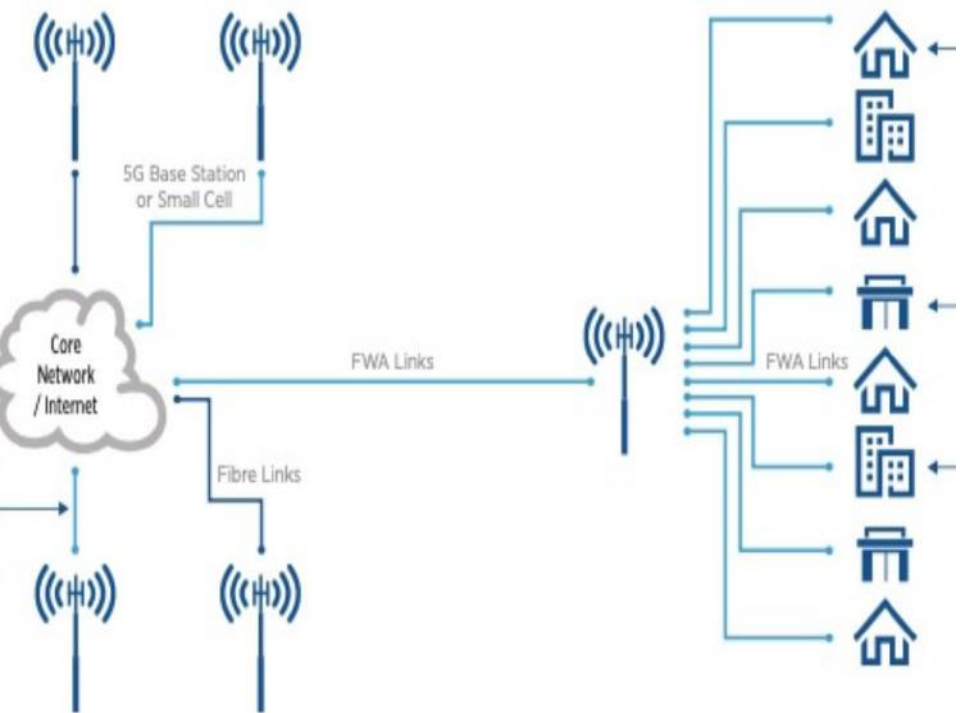

SME



Gas station



Smart school



Smart retail



Mobile bank



Live broadcast



RV



Bus Entertainment

5G examples – smart cities, smart agriculture, smart aqua farming

Remotely controlled or unmanned vehicles for daily tasks in cities. At picture: unmanned vehicle for cleaning streets

Remote control of smart buildings, urban infrastructure. At picture: mass deployment of smart lighting, smoke and air quality sensors

Data collection on weather, soil and equipment with processing in clouds. At picture: unmanned vehicle for harvesting

Video surveillance with 4K video transmissions from underwater cameras. At picture: Smart salmon farm in Norway

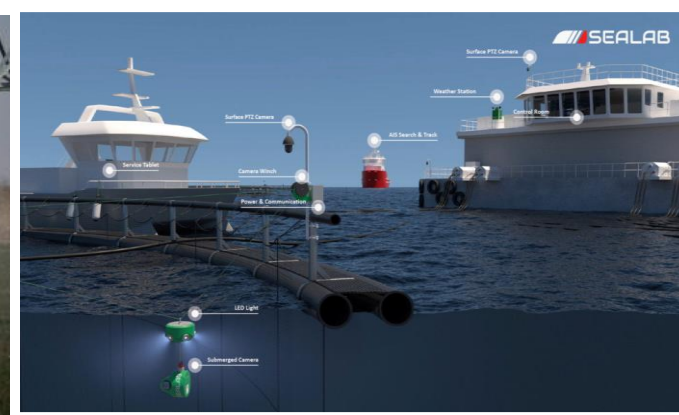

5G examples – Smart medicine, industry

Real time remote ultrasound diagnostics using a robot with 5G support at a distance of more than 400 km. The patient was correctly diagnosed

Chinese factory fully connected to 5G for intelligent inspection, product quality check, security surveillance. 2000 machines, 300 robots, 2000 5G terminals

Finding defects on steel surfaces using 5G. Photos taken by industrial cameras are sent to the cloud via 5G network. Defects are automatically detected using machine vision.

15% effectual products less
85% efficiency increase

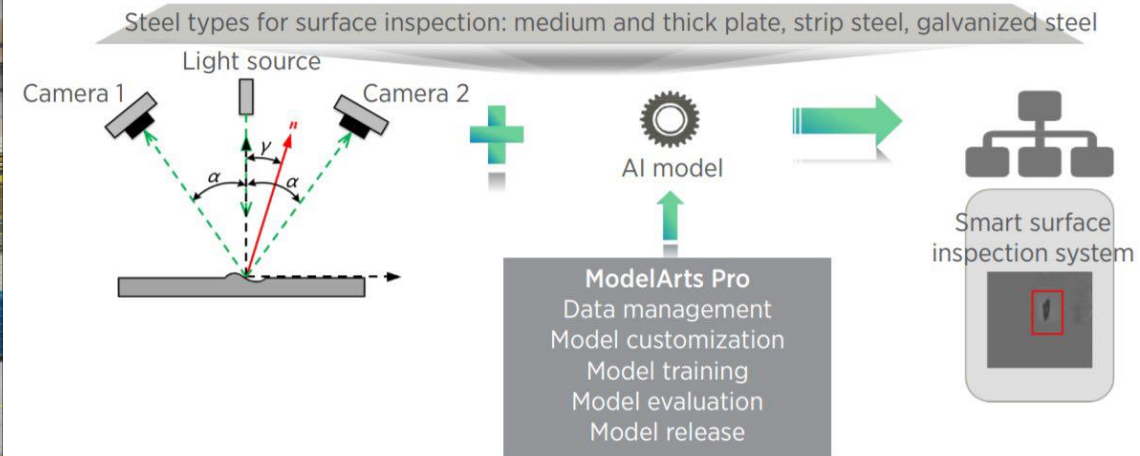

Strategies of 5G deployment



NBTC

National Broadcasting and
Telecommunications Commission

Thailand: creation of National Committee on 5G Strategy +Plan. Spectrum auction with large bands in 700 MHz, 2.6 GHz and 26 GHz. Coverage obligation for cities and main roads. 3 years payments delay for operators. Affordable phones: 150\$ to buy or \$40 + 2 year contract



Switzerland: free conversion of 4G packages into 5G packages with higher data rates. Transfer of valuable 4G users to 5G using iPhones 13Pro. Emphasis on FWA. FTTH dominates only in cities. 5G FWA has 70% share in rural and suburb areas



Korea: 5G is to assist digital economy, a part of Korean Digital strategy (AI, Semiconductors, 5G, Quantum, Metaverse and Cybersecurity). One reason moving to 5G: 4G reached maximum capacity required by customers, especially in video. Main drivers: variety of mobile phones, subsidies, , small price increase to get 5G pack with much more data + entertainment content (partnership with Netflix, YouTube). Frequency bands: 3.4 – 3.7 GHz and 28 GHz .



ITUWRS
GENEVA2022



Some 5G challenges

- **Spectrum** - a set of sufficiently wide bands in various frequency ranges
- **Infrastructure** is needed to provide:
 - small cells
 - backhaul
- **Cost** – more stations, more equipment, higher costs
- **Policy, regulation and business models**
 - rules and incentives for 5G deployment, including in rural areas
 - health impact - EMF limits
- **Technical issues** such as device battery capacity
- **Safety**



Backhauling 5G

- Links between core networks and base stations. Challenges :
 - Capacity of 5G backhaul not less than radio access site
 - Latency should meet the 5G requirements
- Various wireless technologies could serve for 5G backhaul
 - Fiber – adequate capacity, good for cities, $\approx 60\%$ for small cells, but expensive to build, current latency needs improvement
 - Microwave links – the same access technology, good in areas lacking fiber
 - Satellite – up to 200 Mbps, rural area, latency and price could be a problem
 - HAPS – declared rates ≈ 1 Gbps, remote areas, but not operational

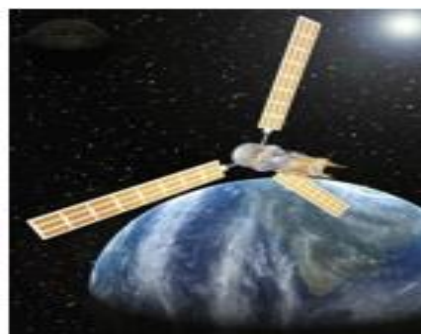

Technology	Rate	latency
Fiber	100 Mbps – 25 Gbps	10 – 30 ms
Microwave links	10 – 100 Mbps, up to 1Gbps	5 – 35 ms
satellite	10 – 200 Mbps (HTP)	100 – 500 ms

Small cells

- Successful 5G rollout relies on networks of small cells, to provide capacity for hotspots: shopping centers, transport hubs, stadiums, etc.
- Small cells: low power BS with coverage of 20 – 300 m installed on street furniture, such as bus shelters, lampposts, traffic lights...
- Ways to facilitate small cells deployment
 - Access to sites -> simple authorization, short application process. Policy-makers may consider wayleave agreements to reduce the cost and time to deploy small cell access points
 - Introducing free of charge regime or reasonable fees for deployment. Policy-makers may consider ensuring reasonable fees for operators to deploy small cell radio equipment onto street furniture



Small cells – country examples

- EU small cell regulations, July 2020
 - a permit-exempt deployment
 - Two-week notification
 - maximum volume 30 litres
 - height min 2,2 metres above walkway
- US FCC rules, September 2018 (*contested by some states*):
 - reasonable authorization and construction fees
 - Time limits for processing applications 60/90 days for existing/new structures
- Singapore - rooftop spaces are free for network operators
- Japan - operators can install 5G BS on 208,000 traffic lights in the country



Content of presentation

- Standards and spectrum for IMT
- Balancing spectrum requirements of IMT and other services
- Regional harmonization of IMT bands and technical conditions
- IMT-2020/5G deployment and challenges
- ITU work on IMT for 2030 and beyond/6G



IMT for 2030 and beyond

Working Party 5D of ITU-R is developing 2 documents on IMT for 2030 and beyond

- Recommendation: **IMT Vision** – Framework and overall objectives of the future development of IMT for 2030 and beyond
- REPORT **IMT future technology trends** of terrestrial IMT systems towards 2030 and beyond



Vision of IMT for 2030 and beyond (6G)

Usage scenarios for 6G would include the development of the 3 existing use cases for IMT-2020 + new scenarios. **Disclaimer:** graph below is one of many proposals of the Vision in ITU-R WP5D

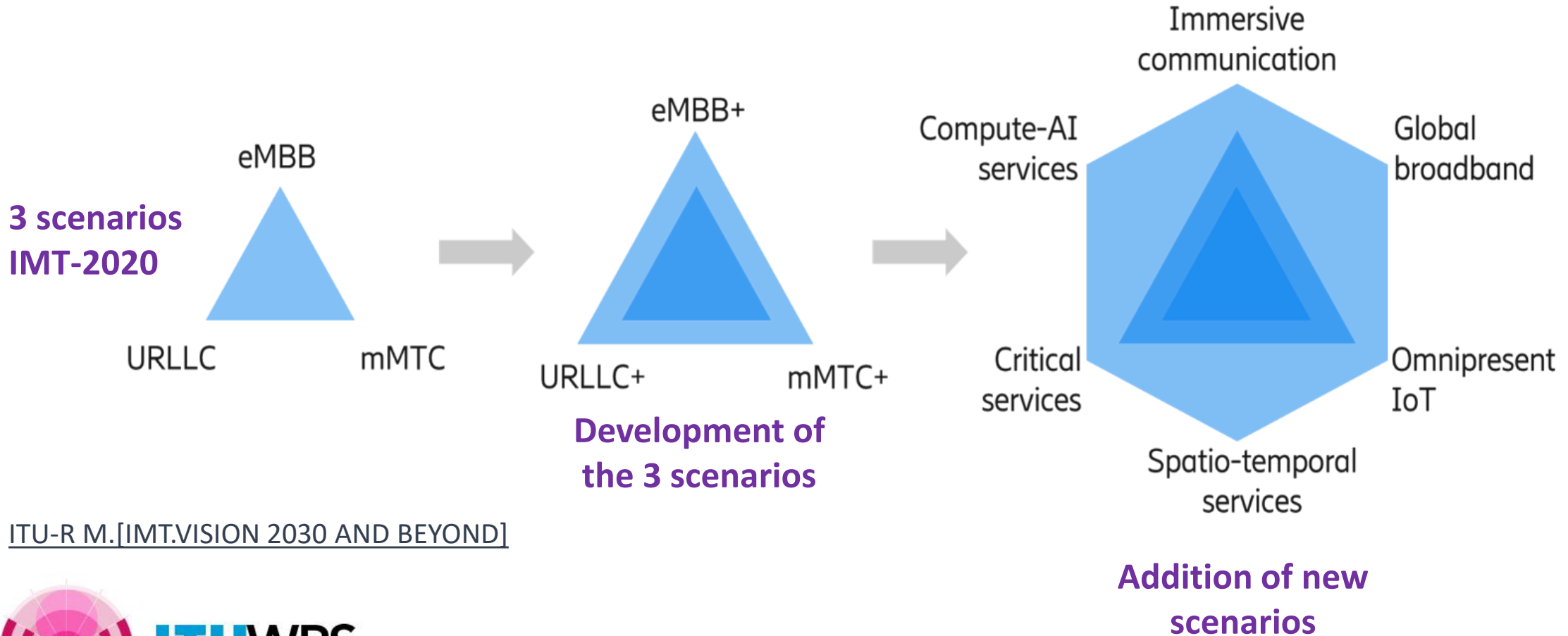

ITU-R M.[IMT.VISION 2030 AND BEYOND]

Usage scenarios and examples

Usage scenario A: Immersive Communication

- extended reality, holographic communications, remote multi-sensory telepresence, tactile feedback ..

Usage scenario B: Extreme/critical Communication

- smart industry, robotics collaboration, drone operation, autonomous driving, remote medical surgery...

Usage scenario C: Massive Communication

- Devices, sensors with long battery life. Smart cities, transport, logistics, health, energy, agriculture..

Usage scenario D: Global mobile connectivity (*discussions in WP5D if this is a separate scenario*)

- Comms of different data rates, everywhere., via integration of terrestrial and non-terrestrial networks

Usage scenario E: Integrated Artificial Intelligence and Communication (*is it a separate scenario ?*)

- AI for network and services, digital twins, automated driving, collaborative robots

Usage scenario F: Joint/Integrated Communication and Sensing

- recognize posture/gestures, localize, track movements. Smart homes, factories, cities, smart highways...

Summary

- ITU-R contributes to IMT by developing high-level standards, allocating frequency resource for IMT and defining conditions for IMT usage
- Spectrum identification for IMT takes place at WRC, taking into account the need for global spectrum harmonization for IMT and for the protection of existing radio services
- An important element of the effective operation of IMT is harmonization of frequency plans and technical conditions at the regional level
- 5G is being deployed in many countries with various business models. Large bands, affordable devices, reasonable policies and incentives are important for 5G success
- 5G should not limit or hamper 4G deployment. 5G is expensive it is difficult to invest in 4G and 5G simultaneously. Priority of investments would be for affordable coverage of rural areas to reduce the digital divide, especially in developing countries. 5G needs to be a means of digital development of countries, rather than following the trend

Thank you!

ITU – Radiocommunication Bureau

Questions to brmail@itu.int

